

TAPE | Placement

Each white rectangle represents a 1" thick strip of double sided tape.
Each shape should require no more than 20" of double sided tape to mount.

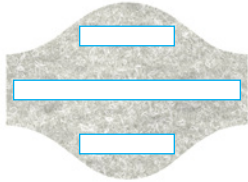

Belt

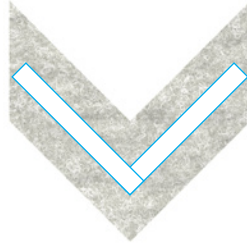

Chevron

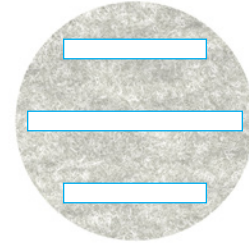

Circle



Dome

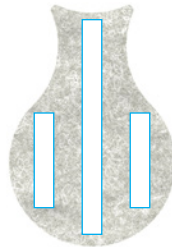

Drop



Stripe

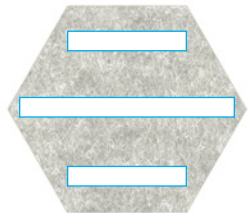

Hexagon

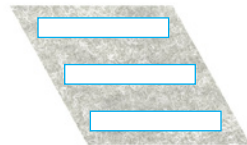

Rhombus

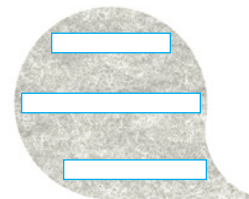

Balloon

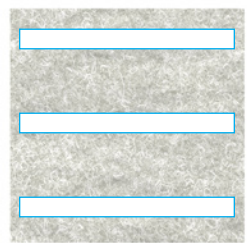

Square

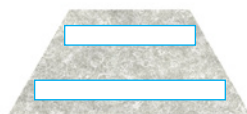

Trapezoid

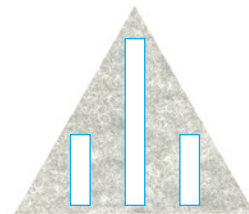

Triangle

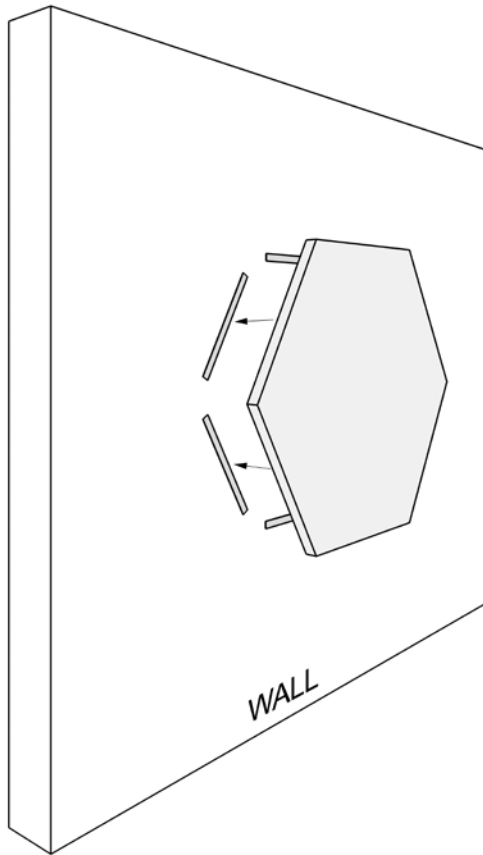

- Clean the surface and the Wall Tile with a damp cloth to remove any debris. Let dry before installing.
- The double sided tape should be pressed tightly across the entire Wall Tile to press out air bubbles and secure a tight bond.
- There is a tolerance range in the Wall Tiles of 1/16". Plan for a 1/8" gap between Wall Tiles for installation.
- Press each tile firmly against the wall for 10-15 seconds to secure a tight bond.

Please contact cc@amqsolutions.com if you are missing any parts, have difficulty with assembly, or have any product related questions.